

**! INFO !**

Do not charge the battery of the towing vehicle and/or towed vehicle directly via the socket.

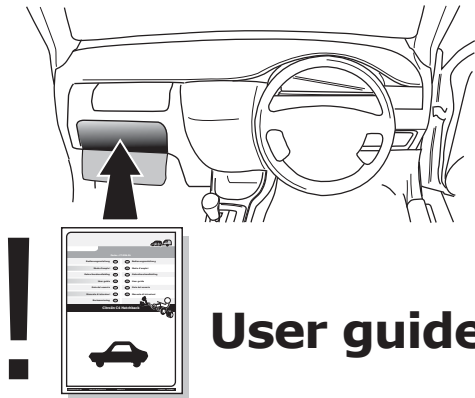

**User guide**

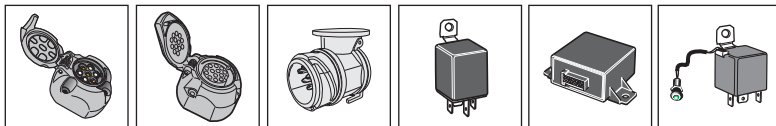

**SPARE PARTS**

**[www.ecs-electronicsuk.co.uk](http://www.ecs-electronicsuk.co.uk)**



Partnr.: MB-077-B1U

**User Guide**

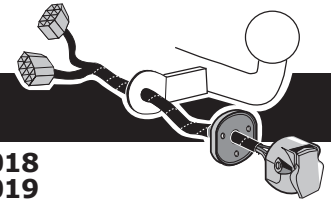

**Mercedes-Benz**

<b>A Class</b>	<b>09/2012 &gt;&gt; 04/2018</b>
<b>B Class</b>	<b>02/2012 &gt;&gt; 01/2019</b>
<b>CLA</b>	<b>04/2013 &gt;&gt; 03/2019</b>
<b>CLA Shooting Brake X117</b>	<b>03/2015 &gt;&gt; 08/2019</b>
<b>GLA X156</b>	<b>03/2014 &gt;&gt; 02/2020</b>

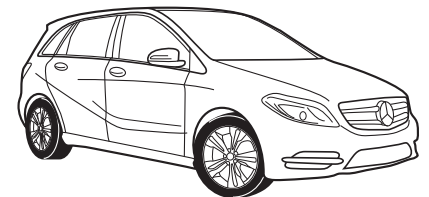
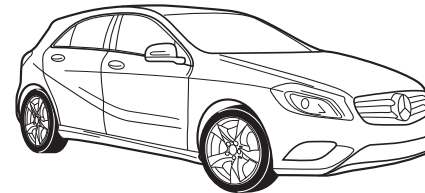

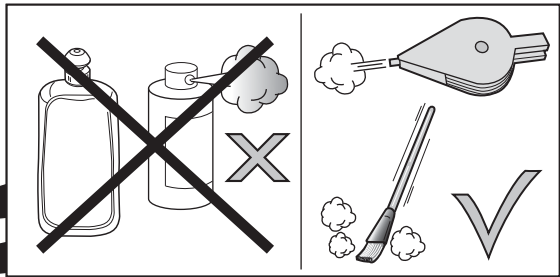
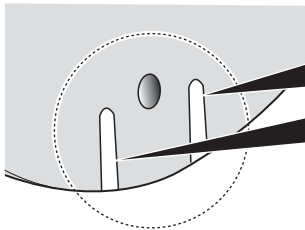
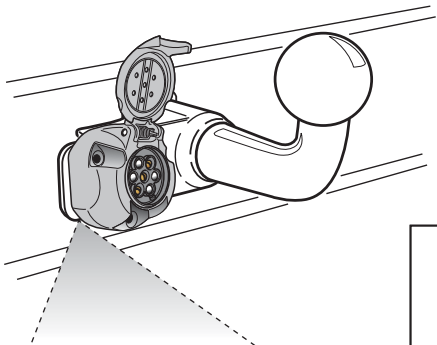
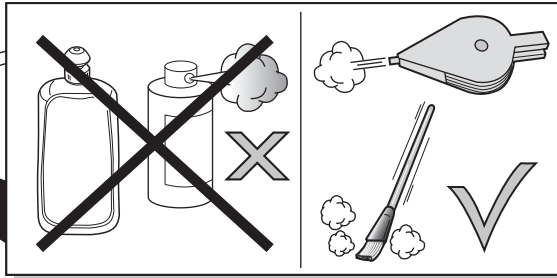
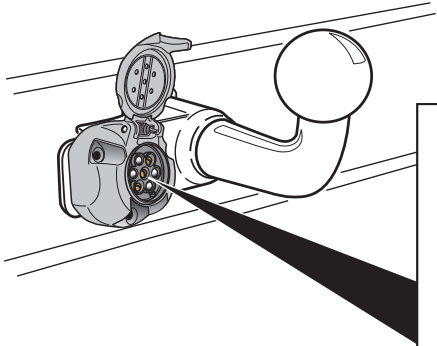
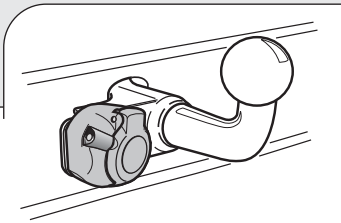

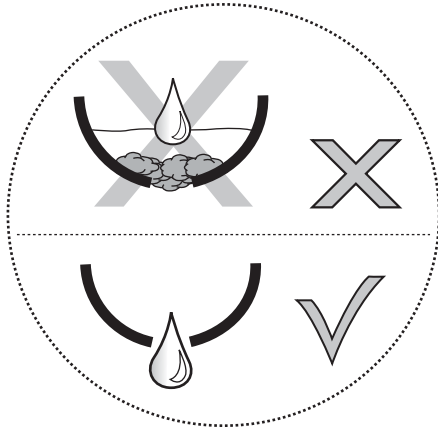
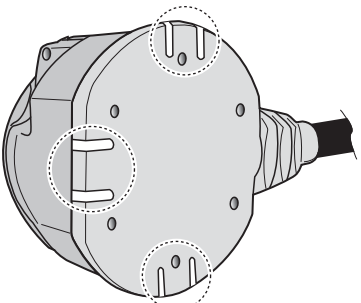
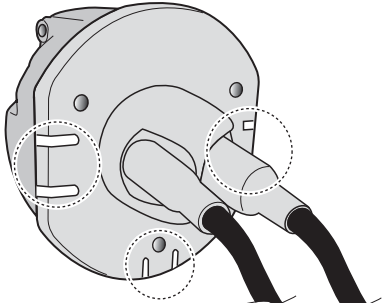
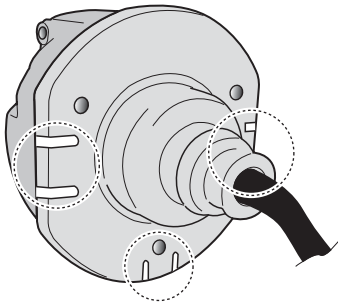
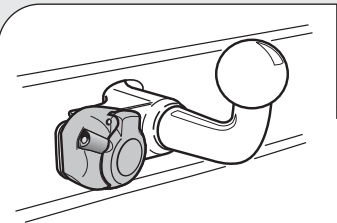

### SOCKET CONNECTION

DIN/ISO 1724							
	1/L	2	3/31	4/R	5/58-R	6/54	7/58-L
Pmax	21W	21W		21W	42W	3x21W	42W
Colour	Yellow	Blue	White	Green	Brown	Red	Black



In a coupled trailer with working fog lamp, the fog lamp of the vehicle will be switched off, if applicable.

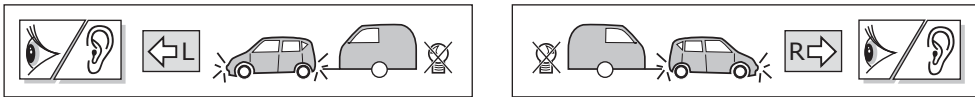

The flashing lights on the trailer are monitored. If one of the indicators of the trailer breaks down, a buzzer will be audible and/or a visual signal will be visible on the dashboard. Check the flashing lights on the trailer.

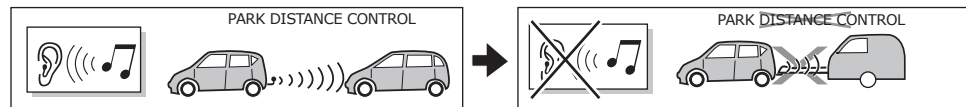

The wiring kit has a possibility to switch off any Park Distance Control in the case of a coupled trailer.

### CHANGING THE FUSE

#### A Class

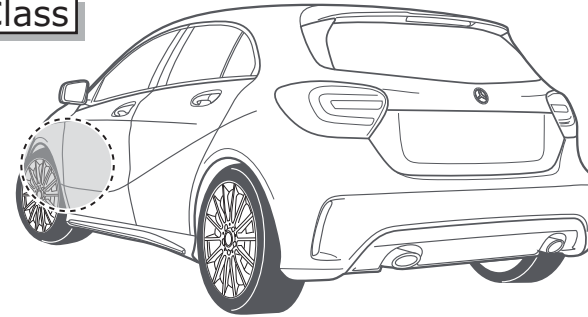

#### B Class

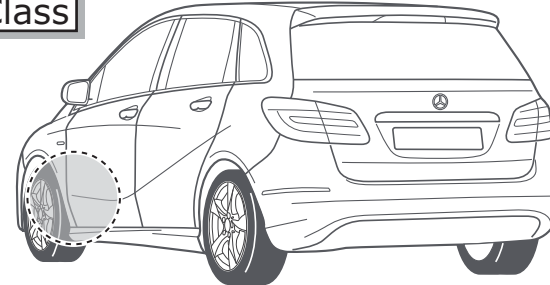

#### CLA Class

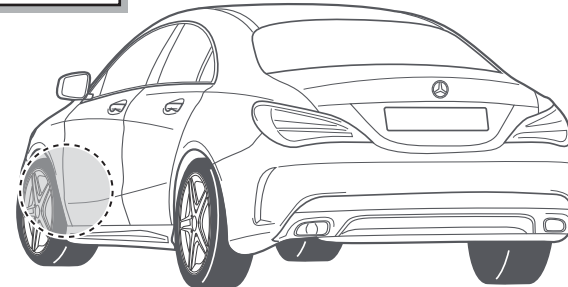

#### GLA Class

